

# MFC/MFA/MFK/MFX400A THYRISTOR/DIODE MODULE



## Features

Isolated mounting base 2500V  
Increased power cycling capability  
Space and weight savings

$I_{T(AV)}$	400A
$V_{DRM}/V_{RRM}$	400-2600 V
$I_{TSM}$	12KA
$I^2T$	720KA <sup>2</sup> S

## Application

AC/DC Motor drives  
Various rectifiers  
DC supply for PWM inverter

Symb.		parameter	Test Conditions	$T_{J(°C)}$	Value	Unit
Current Ratings	$I_{T(AV)}$	average on-state current	180 °half sine wave 50Hz Single side cooled $T_c=85 °C$	125	400	A
	$I_{T(RMS)}$	RMS on-state current		125	628	A
	$I_{TSM}$	Surge on-state current	10ms half sine wave $V_R=0.6V_{RRM}$	125	12.0	KA
	$I^2t$	I <sup>2</sup> T for fusing coordination		125	720	KA <sup>2</sup> S
Characteristics	$V_{DRM}$	Repetitive peak off-state voltage	$V_{DRM} \& V_{RRM}$ tp=10ms	125	400-2600	V
	$V_{RRM}$	Repetitive peak reverse voltage	$V_{DSM} \& V_{RSM} = V_{DRM} \& V_{RRM} + 100V$			
	$I_{DRM}$ $I_{RRM}$	Repetitive peak current	$V_{DM} = V_{DRM}$ $V_{RM} = V_{RRM}$	125	Max.40	mA
	$V_{TO}$	Threshold voltage		125	Max.0.80	V
	$V_{TM}$	Peak on-state voltage	$I_{TM}=1200A$	25	Max.1.52	V
	$r_T$	On-state slop resistance		125	Max.0.49	mΩ
Dynamic Parameters	$I_H$	Holding current	$V_A=12V, I_A=1A$	25	20-200	ma
	dv/dt	Critical rate of rise of off-state voltage	$V_{DM}=67\% V_{DRM}$	125	Max.800	V/μs
	di/dt	Critical rate of rise of on-state current	$I_{TM}=800A, \text{Gate pulse } t_r \leq 0.5\mu s$ $I_{GM}=1.5A$	125	Max.100	A/μs
Gate Parameters	$I_{GT}$	Gate trigger current	$V_A=12V, I_A=1A$	25	30-200	mA
	$V_{GT}$	Gate trigger voltage		25	1.0-3.0	V
	$V_{GD}$	Non-trigger gate voltage	$V_{DM}=67\% V_{DRM}$	125	Min.0.2	V

## Thermal & Mechanical Data

Symb.	parameter	Test Conditions	Value	Unit
$R_{th(j-c)}$	Thermal resistance Junction to case	single side cooled	Max.0.080	°C/W
$R_{th(c-h)}$	Thermal resistance case to heat sink	single side cooled	Max.0.024	°C/W
$V_{iso}$	isolated voltage		Min2500	V
$F_m$	Thermal connection torque(M5)		Typ.12	N m
	Mounting force (M6)		Typ.6	N m
$T_{stg}$	Stored temperature		-40+125	°C
$W_t$	Weight		2300	g

### Outline:

M5

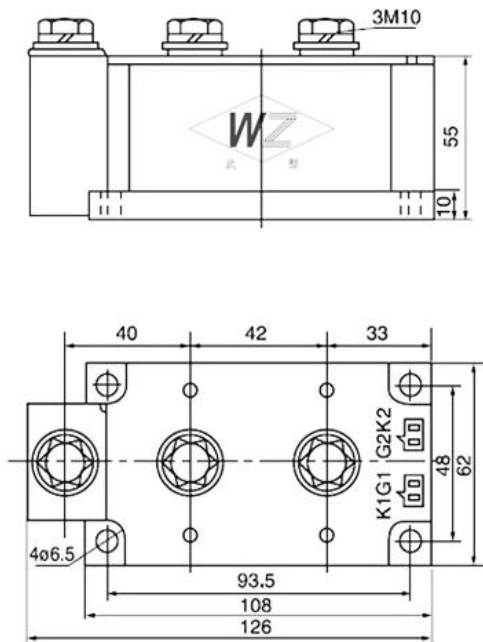

M9

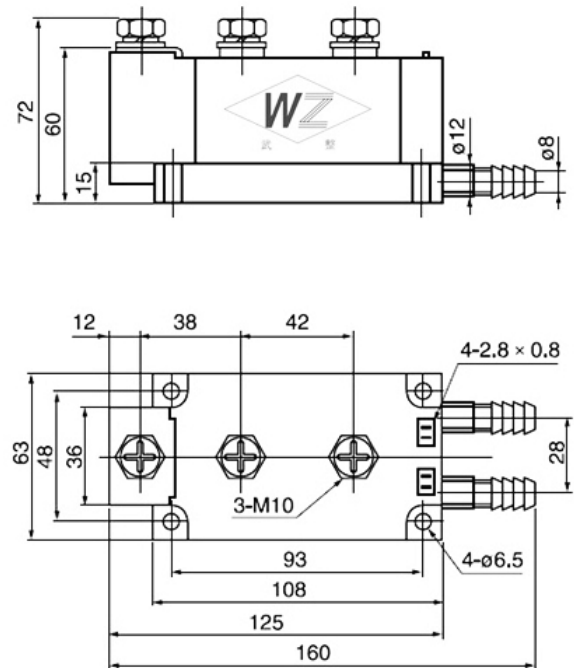

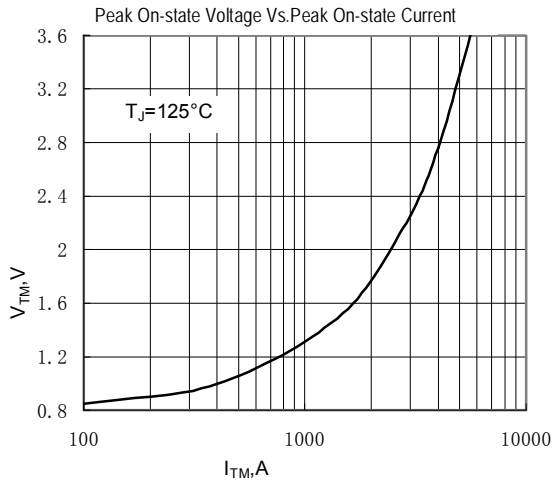

Fig.1

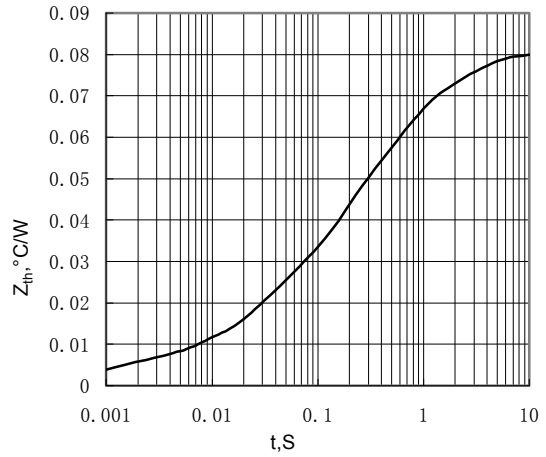

Fig.2

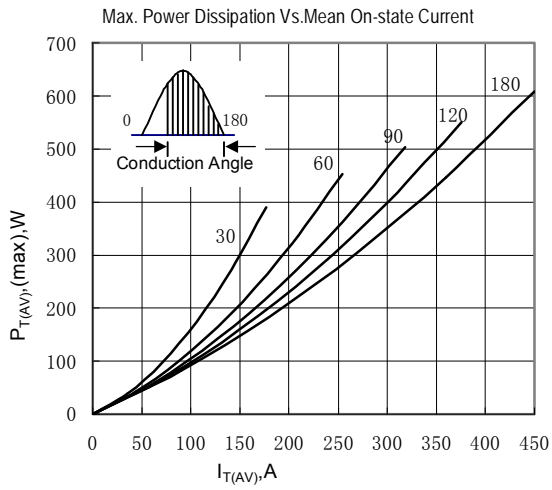

Fig.3

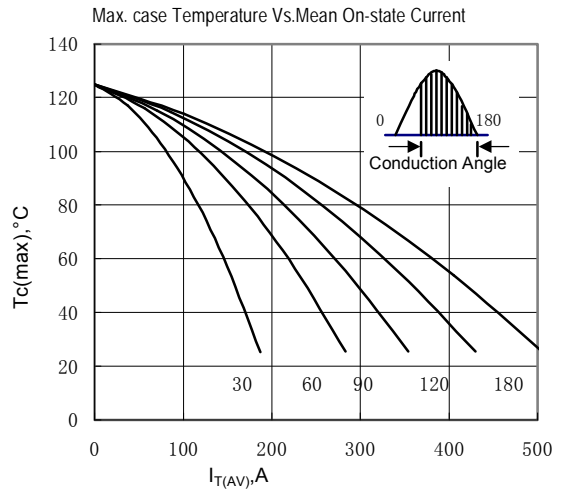

Fig.4

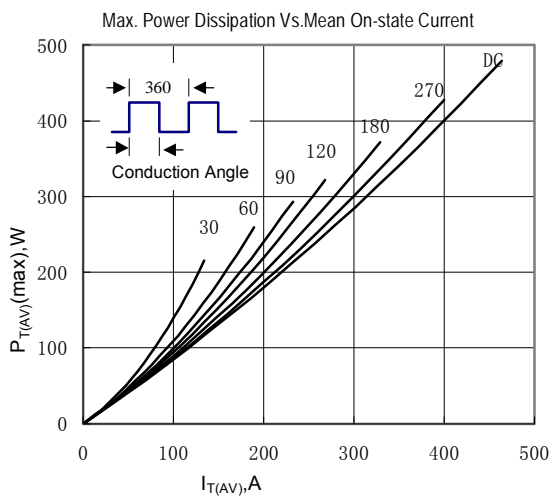

Fig.5

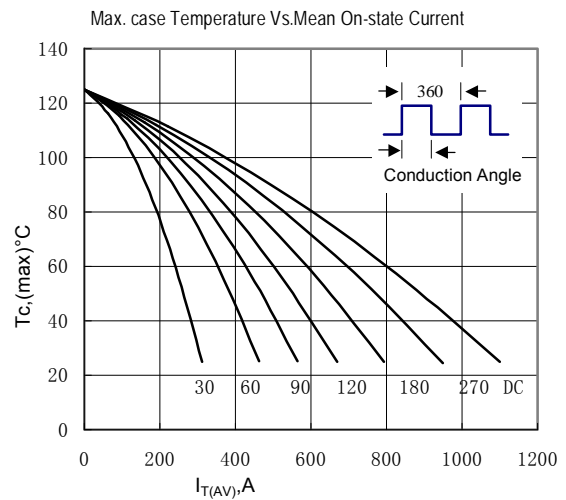

Fig.6

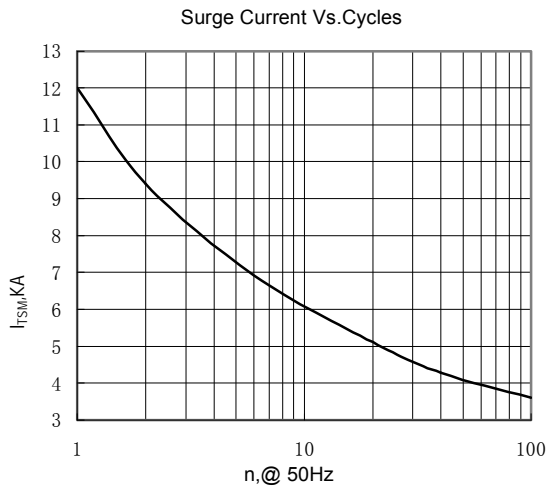

Fig.7

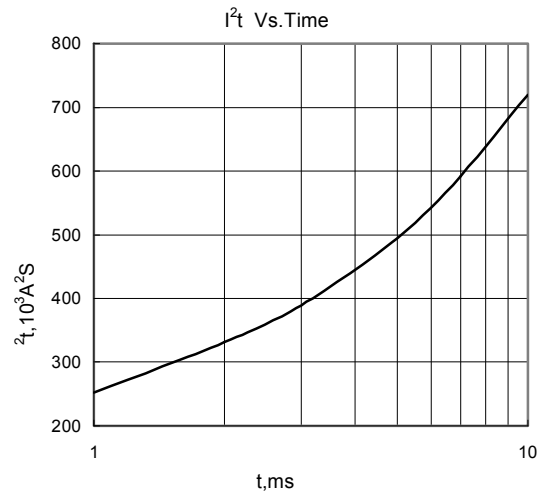

Fig.8

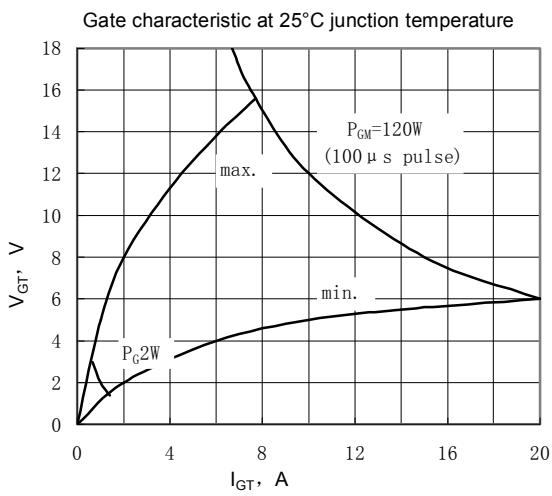

Fig.9

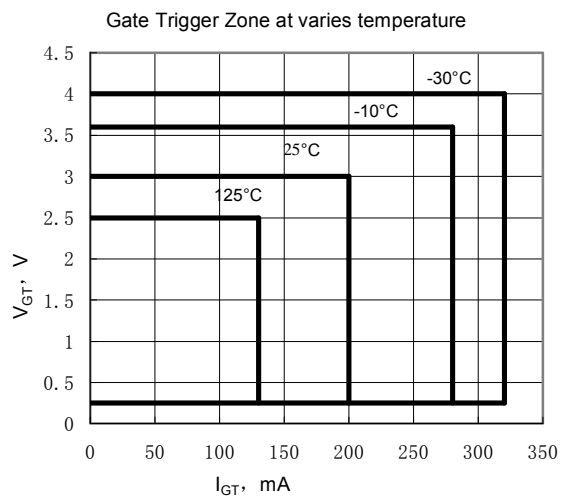

Fig.10

## Wuhan Wuzheng Rectifier Co., Ltd

**Add:** NO. 73 Gaoxin Five Road, East Lake New Technology Development Zone, Wuhan City, Hubei province.

**Tel :** 86-27-87001995

**Fax:** 86-27-87180920

**Email:** info@techele.com

**Web:** www.techele.com/en

cntechele.en.alibaba.com