

KK2500A-G



FAST TURN-OFF THYRISTOR

Features

- Interdigitated amplifying gate
- Fast switch and high di/dt
- Low switching loss

Application

- Converter
- Chopper
- Induction heating

$I_{T(AV)}$	2500 A
V_{DRM}/V_{RRM}	1900~2500V
t_q	35~70 μ s
I_{TSM}	27KA
I^2T	3645KA ² S

Symb.		parameter	Test Conditions	$T_{J(c)}$)	Value	Unit
Current Ratings	$I_{T(AV)}$	average on-state current	180° half sine wave 50Hz Double side cooled $T_{hs}=55^{\circ}C$	115	2500	A
	I_{TSM}	Surge on-state current	10ms half sine wave $V_R=0.6V_{RRM}$	115	27	KA
	I^2t	I^2t for fusing coordination		115	3645	KA ² S
Characteristics	V_{DRM} V_{RRM}	Repetitive peak off-state voltage Repetitive peak reverse voltage	$V_{DRM}\&V_{RRM}$ tp=10ms $V_{DSM}\&V_{RSM}=V_{DRM}\&V_{RRM}+100V$	115	1900-2500	V
	I_{DRM} I_{RRM}	Repetitive peak current	$V_{DM}=V_{DRM}$ $V_{RM}=V_{RRM}$	115	Max.200	mA
	V_{TO}	Threshold voltage		115	Max.1.48	V
	V_{TM}	Peak on-state voltage	$I_{TM}=5000A, F=40KN$	25	Max.3.15	V
	r_T	On-state slop resistance		115	0.18	m Ω
	I_H	Holding current	$V_A=12V, I_A=1A$	25	20-1000	mA
Dynamic Parameters	dv/dt	Critical rate of rise of off-state voltage	$V_{DM}=67\%V_{DRM}$	115	Max.500	V/ μ s
	di/dt	Critical rate of rise of on-state current	$V_{DM}=67\%V_{DRM}$ to 2000A, Gate pulse $t_r \leq 0.5\mu s, I_{GM}=1.5A$	115	Max.600	A/ μ s
	t_q	Circuit commutated turn-off time	$I_{TM}=1000A, tp=1000\mu s, dv/dt=30V/\mu s$ $di/dt=-20A/\mu s, V_R=50V$	115	Min.35 Max.70	mA
	I_{rm}	Reserse recovery current	$I_{TM}=1000A, tp=1000\mu s$ $di/dt=-20A/\mu s, V_R=50V$	115	Typ.187	A
	t_{rr}	Reverse recovery time		115	Typ.11.2	μ s
	Q_{rr}	Recovery charge		115	Typ.1049 Max.1200	μ c
Gate Parameters	I_{GT}	Gate trigger current	$V_A=12V, I_A=1A$	25	40-450	mA
	V_{GT}	Gate trigger voltage		25	0.9-4.5	V
	V_{GD}	Non-trigger gate voltage	$V_{DM}=67\%V_{DRM}$	115	Min.0.3	V

Thermal & Mechanical Date

Symb.	parameter	Test Conditions	Value	Unit
$R_{th(j-h)}$	Thermal resistance Junction to heat sink	Double side cooled, mounting force 40KN	0.011	°C/W
F_m	Mounting force		35-47	KN
T_{stg}	Stored temperature		-40--+140	°C
W_t	Weight		1100	g

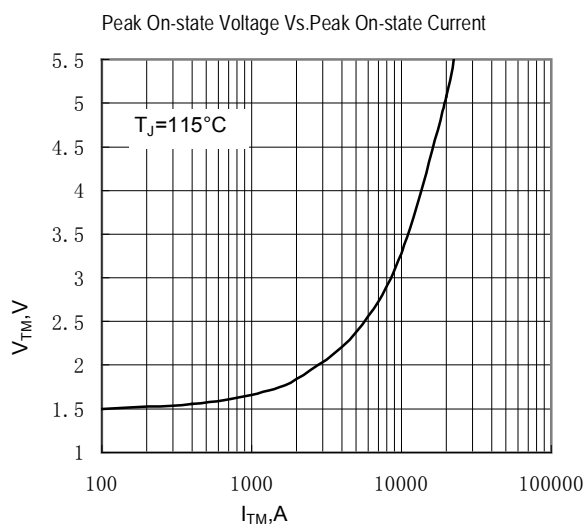

Fig.1

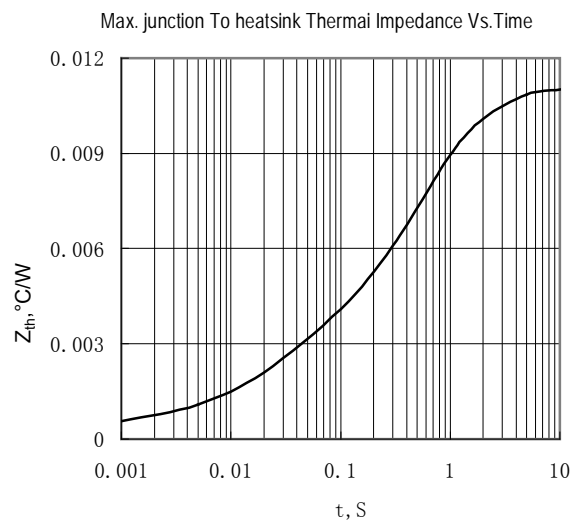

Fig.2

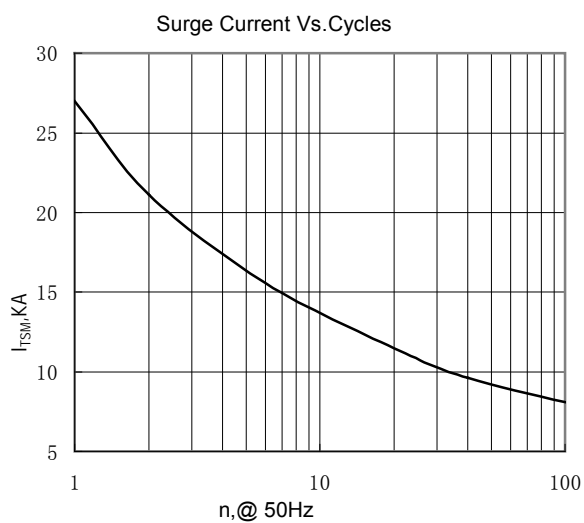

Fig.3

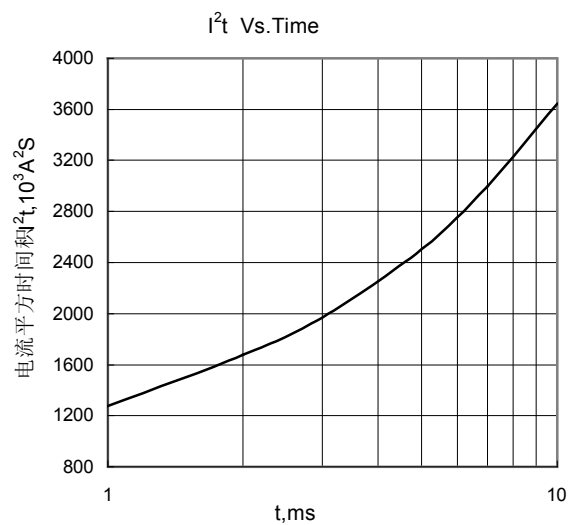

Fig.4

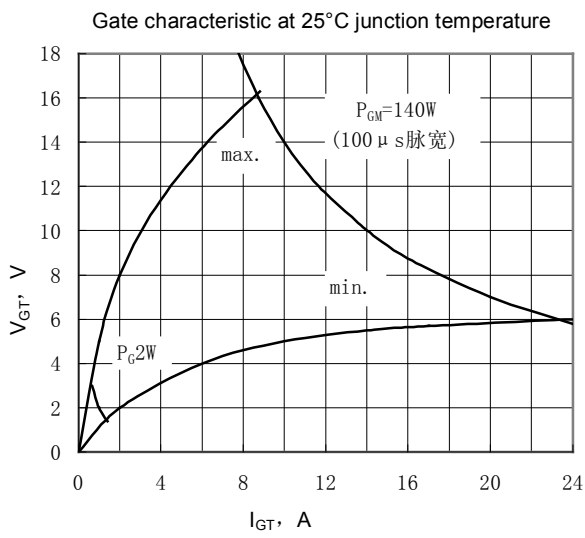

Fig.5

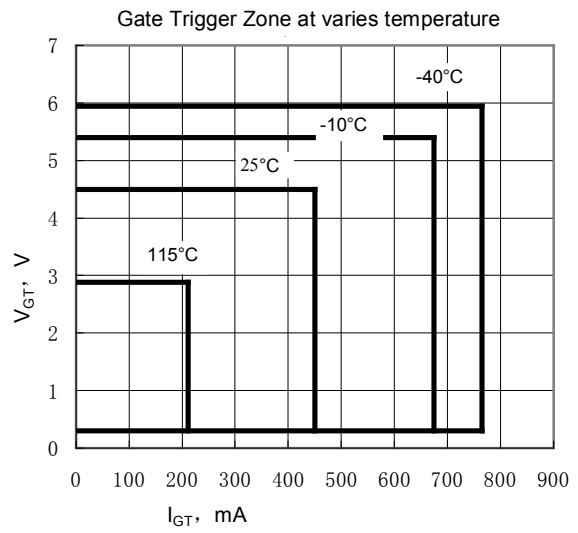
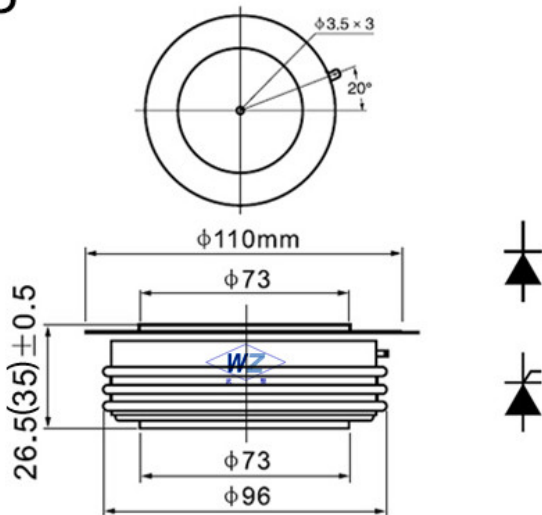

Fig.6

Dimensions:

C25



Wuhan Wuzheng Rectifier Co., Ltd

Add: NO. 73 Gaoxin Five Road, East Lake New Technology Development Zone, Wuhan City, Hubei province.

Tel : 86-27-87001995

Fax: 86-27-87180920

Email: info@techele.com

Web: www.techele.com/en

cn-techele.en.alibaba.com