

KP3500A-C



PHASE CONTROL THYRISTOR

Features

- Center amplifying gate
- Metal case with ceramic insulator
- Low on-state and switching losses

Application

- Large power converter
- DC and AC switches
- Active & Passive inverter

$I_{T(AV)}$	3500 A
V_{DRM}/V_{RRM}	400~1000 V
I_{TSM}	44KA
I^2T	9680 KA ² S

Symb.		parameter	Test Conditions	$T_{J(C)}$	Value	Unit
Current Ratings	$I_{T(AV)}$	Average on-state current	180° half sine wave 50Hz Double side cooled $T_{hs}=70^{\circ}C$	125	3500	A
	$I_{T(AV)}$	Average on-state current	180° half sine wave 50Hz Double side cooled $T_{hs}=55^{\circ}C$	125	4148	A
	I_{TSM}	Surge on-state current	10ms half sine wave $V_R=0.6V_{RRM}$	125	44	KA
	I^2t	I^2T for fusing coordination		125	9680	KA ² S
Characteristics	V_{DRM} V_{RRM}	Repetitive peak off-state voltage Repetitive peak reverse voltage	V_{DRM} & V_{RRM} $t_p=10ms$ V_{DSM} & $V_{RSM}=V_{DRM}$ & $V_{RRM}+100V$	125	400-1000	V
	I_{DRM} I_{RRM}	Repetitive peak current	$V_{DM}=V_{DRM}$ $V_{RM}=V_{RRM}$	125	Max.200	mA
	V_{TO}	Threshold voltage		125	Max.0.82	V
	V_{TM}	Threshold voltage	$I_{TM}=5000A, F=40KN$	25	Max.1.80	V
	r_T	On-state slop resistance		125	Max.0.07	mΩ
	I_H	Holding current	$V_A=12V, I_A=1A$	25	20-300	mA
Dynamic Parameters	dv/dt	Critical rate of rise of off-state voltage	$V_{DM}=67\%V_{DRM}$	125	Max.300	V/μs
	di/dt	Critical rate of rise of on-state current	$V_{DM}=67\%V_{DRM}$ to 600A, Gate pulse $t_r \leq 0.5\mu s$ $I_{GM}=1.5A$	125	Max.250	A/μs
	t_{rr}	Reverse recovery time	$I_{TM}=500A, t_p=1000\mu s, V_R=50V$ $di/dt=-20A/\mu s$	125	22	μs
	Q_{rr}	Reverse Recovery charge		125	2420	μc
Gate Parameters	I_{GT}	Gate trigger current	$V_A=12V, I_A=1A$	25	40-300	mA
	V_{GT}	Gate trigger voltage		25	0.8-3.0	V
	V_{GD}	Non-trigger gate voltage	$V_{DM}=67\%V_{DRM}$	125	Min.0.3	V

Thermal & Mechanical Data

Symb.	parameter	Test Conditions	$T_{J(°C)}$	Value	Unit
$R_{th(j-h)}$	Thermal resistance Junction to heat sink	At 180° sine wave, double side cooled Clamping force 40KN		Max.0.011	°C/W
F_m	Mounting force			35-47	KN
T_{stg}	Stored temperature			-40-140	°C
W_t	Weight			1100	g

Dimensions:

C25

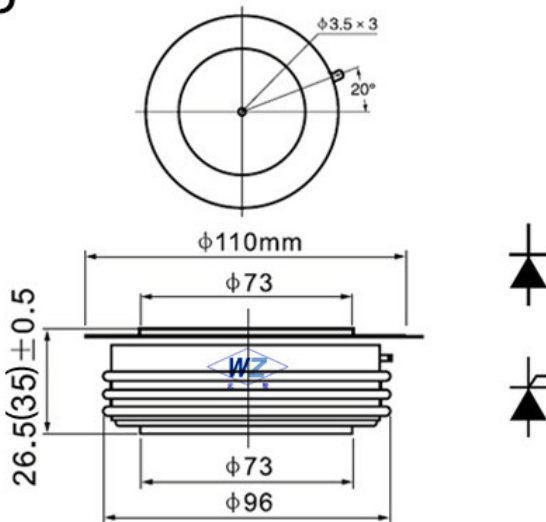

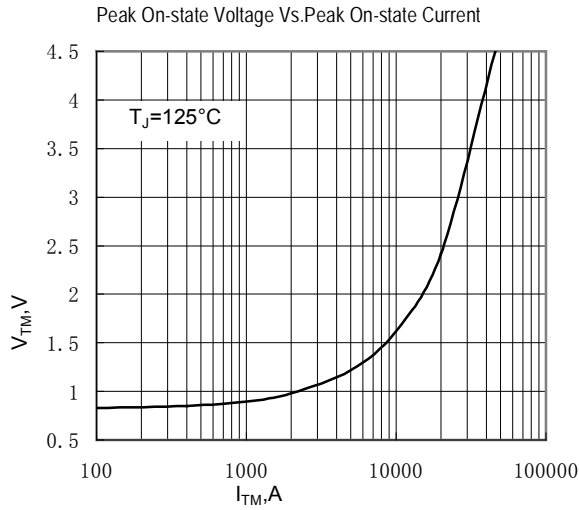

Fig.1

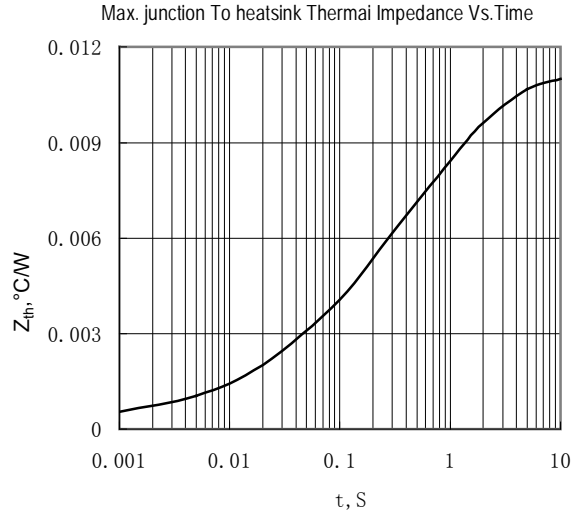

Fig.2

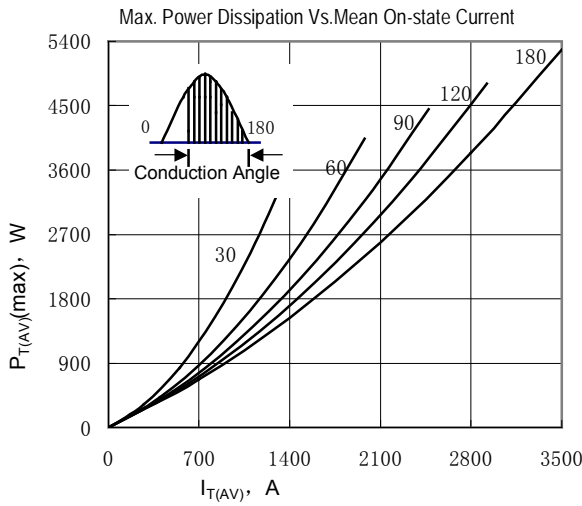

Fig.3

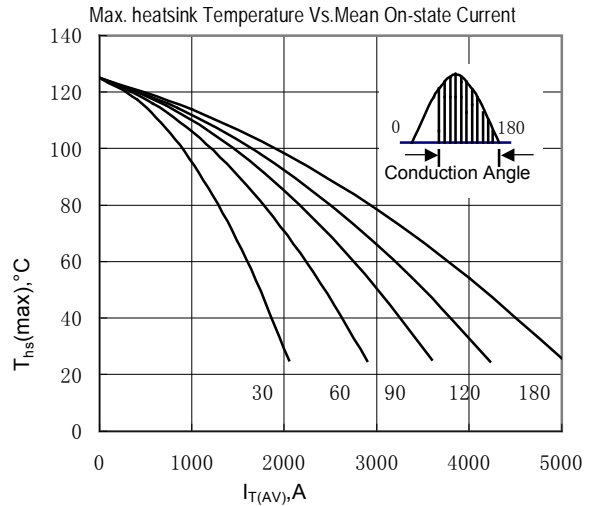

Fig.4

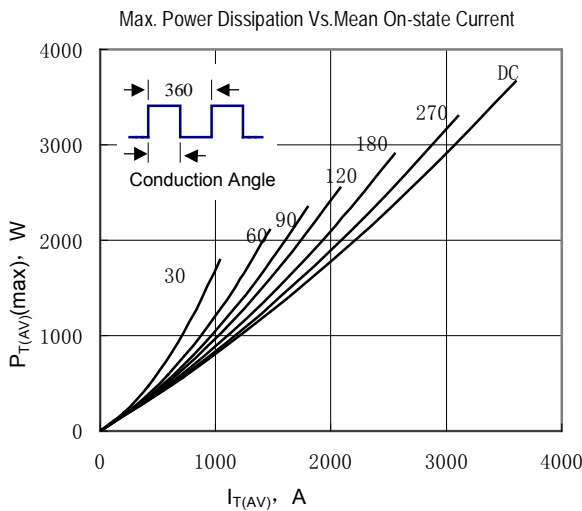

Fig.5

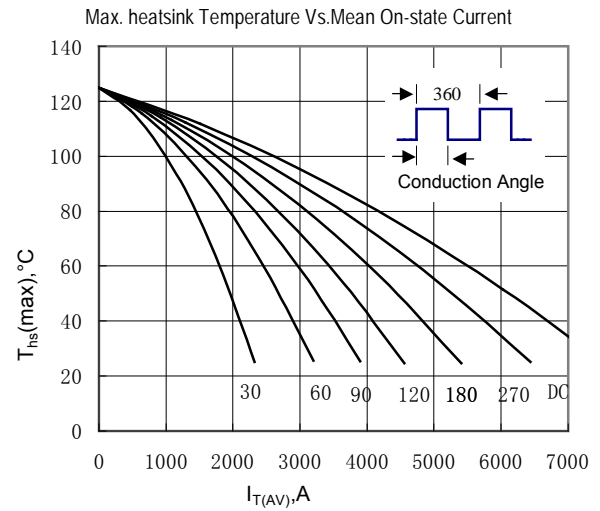

Fig.6

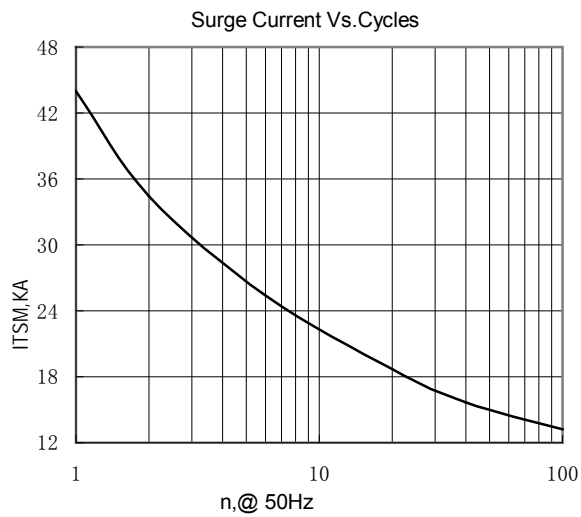

Fig.7

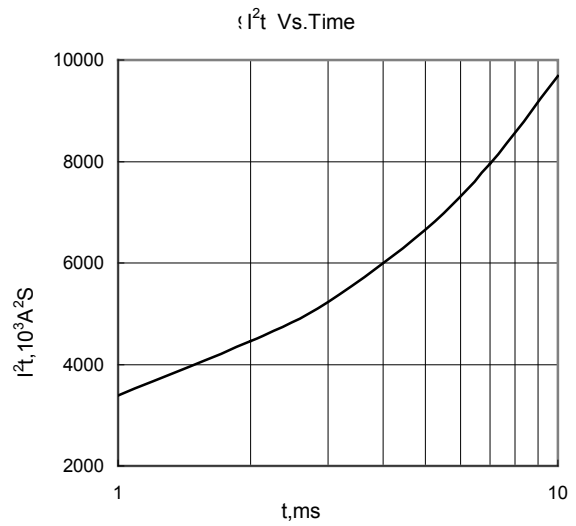

Fig.8 I^2t

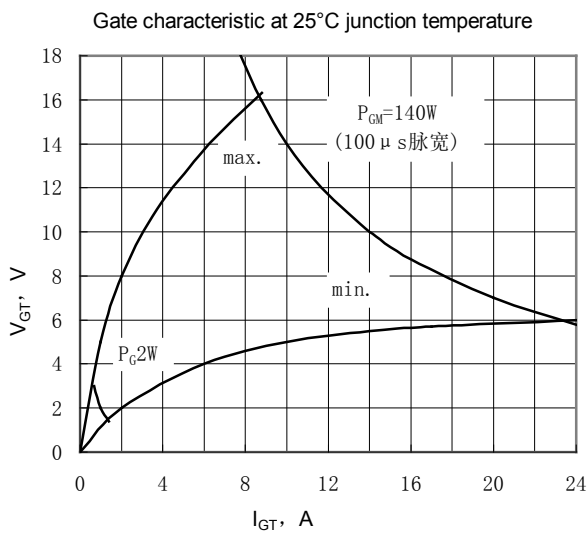

Fig.9

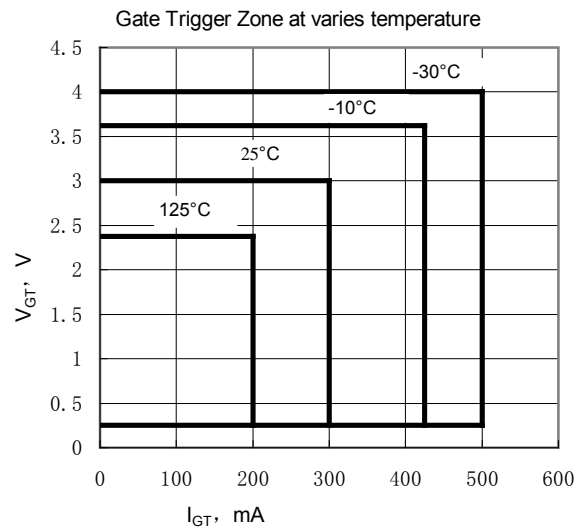

Fig.10

Wuhan Wuzheng Rectifier Co., Ltd

Add: NO. 73 Gaoxin Five Road, East Lake New Technology Development Zone, Wuhan City, Hubei province.

Tel : 86-27-87001995

Fax: 86-27-87180920

Email: info@techele.com

Web: www.techele.com/en

cntechele.en.alibaba.com