

KP1600A-E

PHASE CONTROL THYRISTOR



Features

Center amplifying gate
Metal case with ceramic insulator
Low on-state and switching losses

Application

Large power converter
DC and AC switches
Active & Passive inverter

$I_{T(AV)}$	1600 A
V_{DRM}/V_{RRM}	1100~1800 V
I_{TSM}	20KA
I^2t	2000 KA ² S

Symb.		parameter	Test Conditions	$T_{J(C)}$	Value	Unit
Current Ratings	$I_{T(AV)}$	Average on-state current	180° half sine wave 50Hz Double side cooled $T_{hs}=61^{\circ}C$	125	1600	A
	$I_{T(AV)}$	Average on-state current	180° half sine wave 50Hz Double side cooled $T_{hs}=55^{\circ}C$	125	1712	A
	I_{TSM}	Surge on-state current	10ms half sine wave $V_R=0.6V_{RRM}$	125	20	KA
	I^2t	I^2t for fusing coordination		125	2000	KA ² S
Characteristics	V_{DRM} V_{RRM}	Repetitive peak off-state voltage Repetitive peak reverse voltage	$V_{DRM} \& V_{RRM} t_p=10ms$ $V_{DSM} \& V_{RSM} = V_{DRM} \& V_{RRM} + 100V$	125	1100-1800	V
	I_{DRM} I_{RRM}	Repetitive peak current	$V_{DM} = V_{DRM}$ $V_{RM} = V_{RRM}$	125	Max.100	mA
	V_{TO}	Threshold voltage		125	Max.1.10	V
	V_{TM}	Threshold voltage	$I_{TM}=4000A, F=26KN$	25	Max.2.20	V
	r_T	On-state slop resistance		125	Max.0.18	mΩ
	I_H	Holding current	$V_A=12V, I_A=1A$	25	20-300	mA
Dynamic Parameters	dv/dt	Critical rate of rise of off-state voltage	$V_{DM}=67\%V_{DRM}$	125	Max.300	V/μs
	di/dt	Critical rate of rise of on-state current	$V_{DM}= 67\%V_{DRM}$ to 600A, Gate pulse $t_r \leq 0.5\mu s$ $I_{GM}=1.5A$	125	Max.200	A/μs
	t_{rr}	Reverse recovery time	$I_{TM}=500A, t_p=1000\mu s, V_R=50V$ $di/dt=-20A/\mu s$	125	18.2	μs
	Q_{rr}	Reverse Recovery charge		125	1394	μc
Gate Parameters	I_{GT}	Gate trigger current	$V_A=12V, I_A=1A$	25	40-300	mA
	V_{GT}	Gate trigger voltage		25	0.8-3.0	V
	V_{GD}	Non-trigger gate voltage	$V_{DM}=67\%V_{DRM}$	125	Min.0.3	V

Thermal & Mechanical Data

Symb.	parameter	Test Conditions	T _{J(°C)}	Value	Unit
R _{th(j-h)}	Thermal resistance Junction to heat sink	At 180° sine wave, double side cooled Clamping force 26KN		0.022	°C/W
F _m	Mounting force			21-30	KN
T _{stg}	Stored temperature			-40-140	°C
W _t	Weight			620	g

Dimensions:

C21

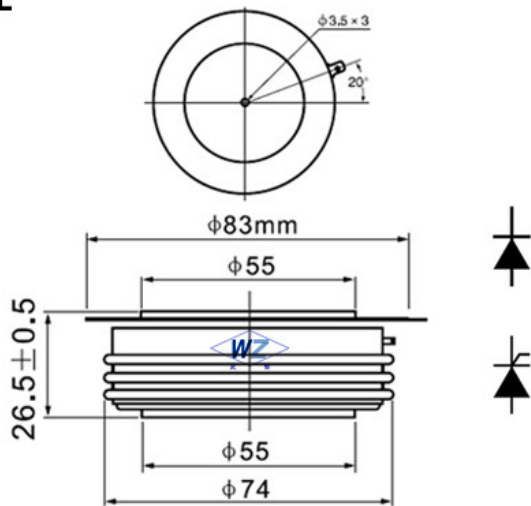

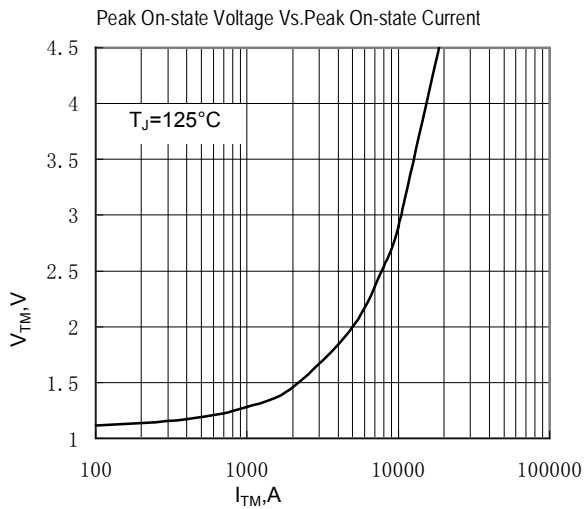

Fig.1

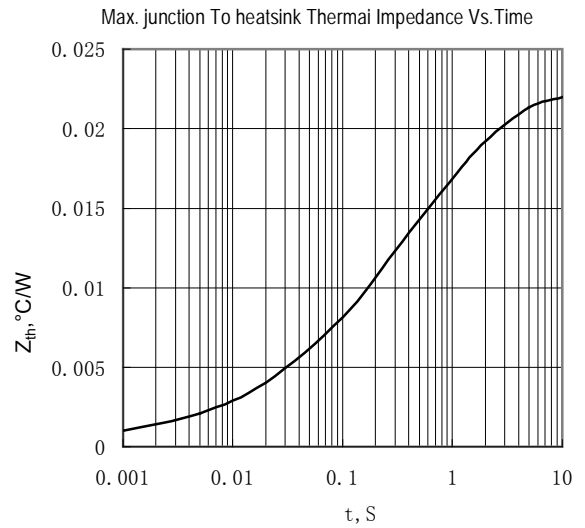

Fig.2

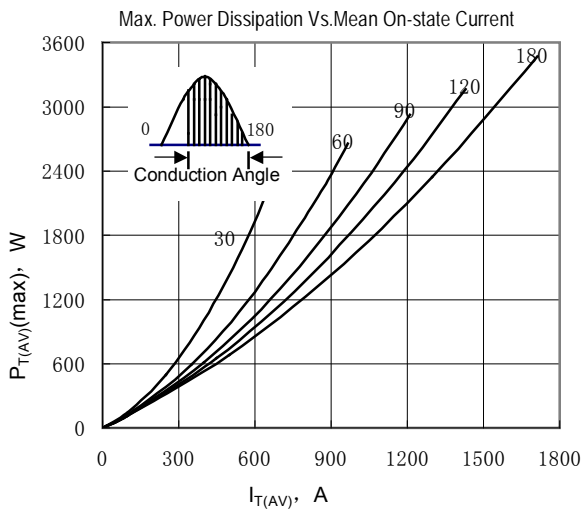

Fig.3

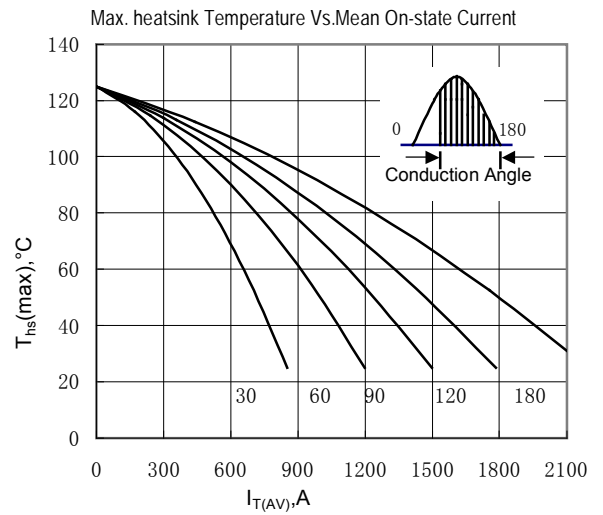

Fig.4

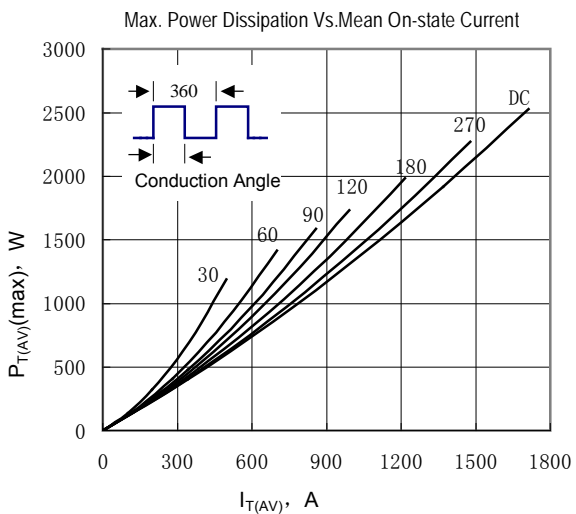

Fig.5

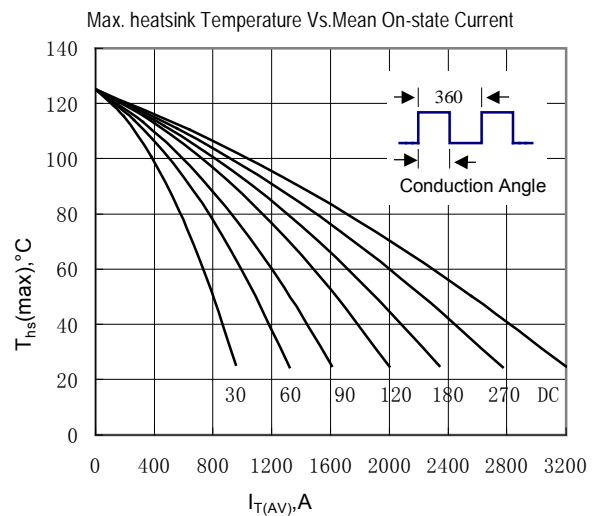

Fig.6

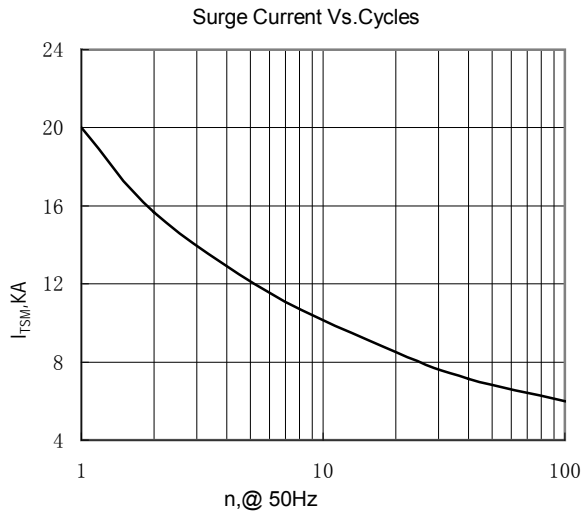

Fig.7

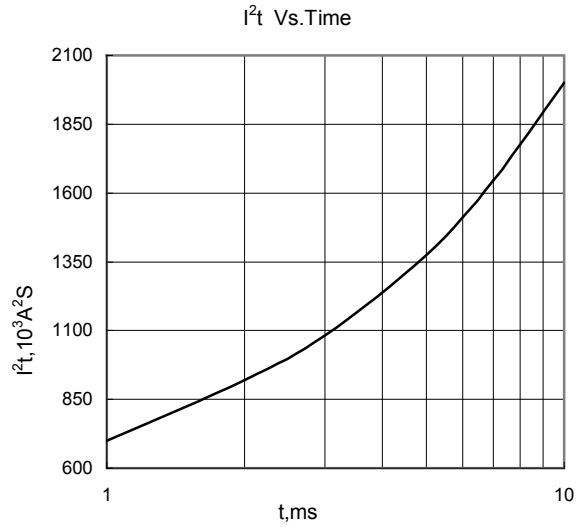

Fig.8

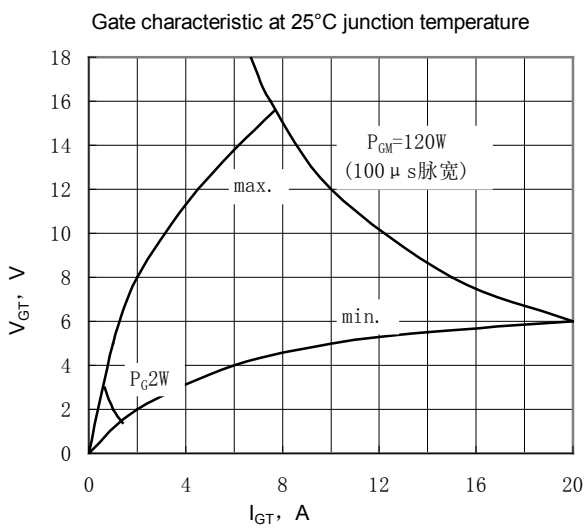

Fig.9

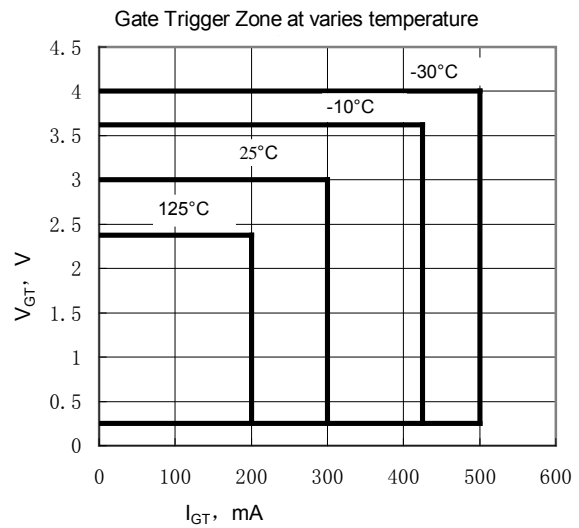

Fig.10

外形图:

Wuhan Wuzheng Rectifier Co., Ltd

Add: NO. 73 Gaoxin Five Road, East Lake New Technology Development Zone, Wuhan City, Hubei province.

Tel : 86-27-87001995

Fax: 86-27-87180920

Email: info@techele.com

Web: www.techele.com/en

cn-techele.en.alibaba.com