

ZP1000A-B STANDARD RECOVERY DIODE



Features

- Low forward voltage drop
- Soft recovery
- Hermetic metal cases with ceramic insulators

Application

- Inverters and choppers
- AC. motor control
- Snubber and free-wheeling diodes

$I_{F(AV)}$	1000A
V_{RRM}	200-1000V
I_{FSM}	14KA
I^2t	980KA ² S

SYMBOL		PARAMETERS	TESTING CONDITION	$T_j(^{\circ}C)$	VALUES	UNIT
Current Tatings	$I_{F(AV)}$	average forward current	180° half sine wave 50Hz Double side cooled, $T_{hs}=112^{\circ}C$	150	1000	A
	$I_{F(AV)}$	average forward current	180° half sine wave 50Hz Double side cooled, $T_{hs}=55^{\circ}C$	150	1928	A
	I_{FSM}	Surge forward current	10ms half sine wave	150	14	KA
	I^2t	I^2t for fusing coordination	$VR=0.6VRRM$	150	980	KA ² S
Characteristics	V_{RRM}	Repetitive peak reverse voltage	$V_{RRM} tp=10ms$ $V_{RSM}=V_{RRM}+100V$	150	200-1000	V
	I_{RRM}	Repetitive peak current	$V_{RM}=V_{RRM}$	150	Max.50	Ma
	V_{FM}	Peak on-state voltage	$I_{TM}=3000A, F=18KN$	25	Max.2.0	V
	V_{FO}	Threshold voltage		150	Max.0.86	V
	r_F	Forward slop resistance			Max.0.165	mΩ
	I_{rm}	Reverse recovery current	$I_{TM}=1000A, t_p=1000\mu s,$ $di/dt=-20A/\mu s, Vr=50V$	100	Max.110	A
	t_{rr}	Reverse recovery time			Max.4.5	μs
Q_{rr}	Recovery charge	Max.247			μc	
Thermal &Mechanical Date	$R_{th(j-h)}$	Thermal resistance Junction to heat sink	At 180° sine, double side cooled mounting force 15KN		Max.0.030	°C/W
	F_m	Mounting force			15-20	KN
	T_{stg}	Stored temperature			-40-160	°C
	W_t	Weight			360	g

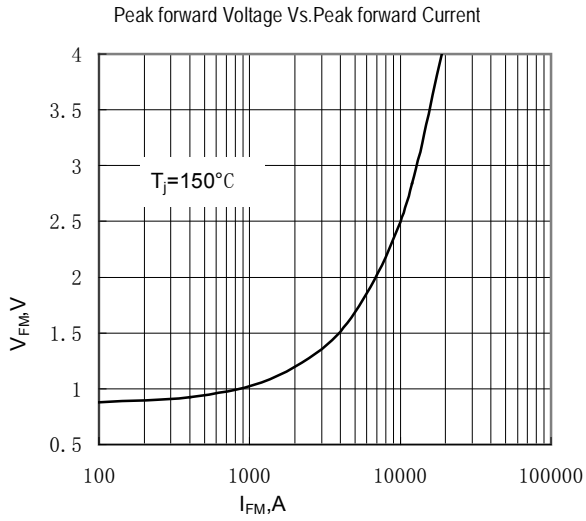

Fig.1

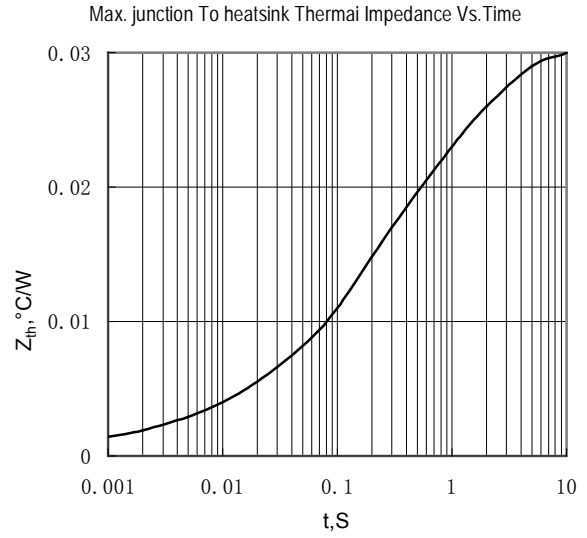

Fig.2

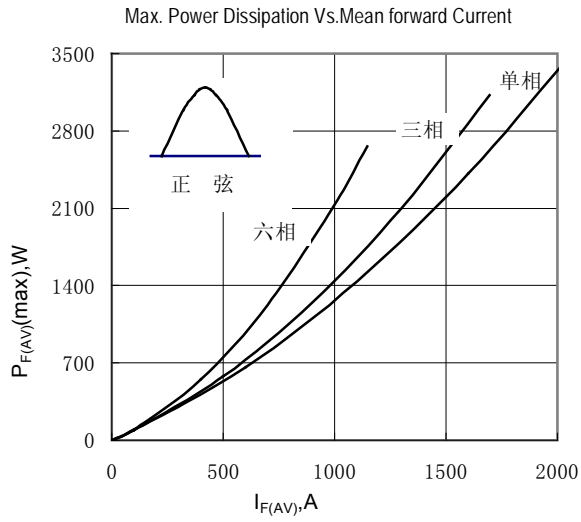

Fig.3

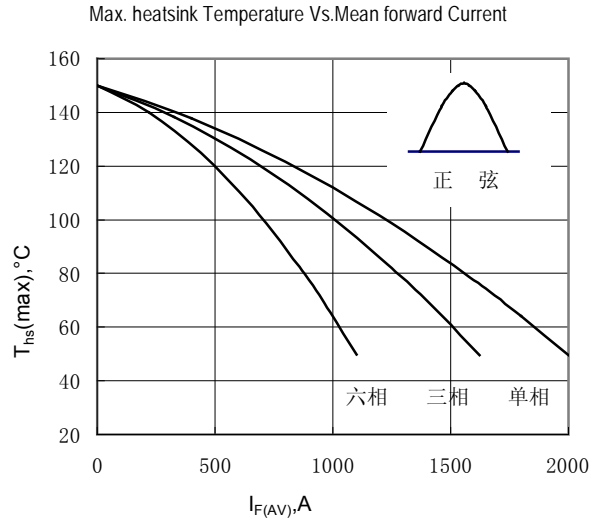

Fig.4

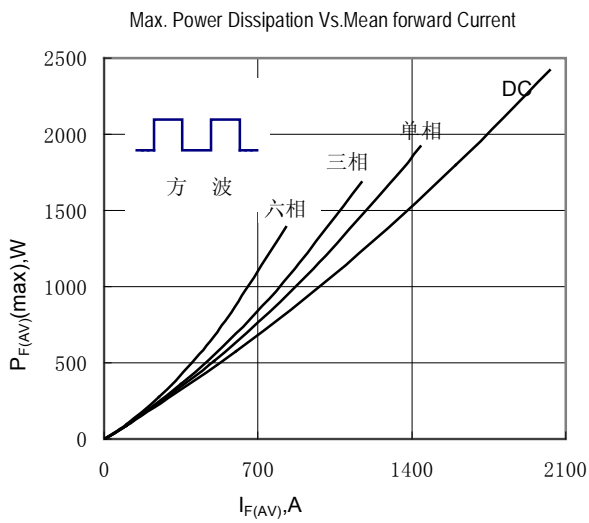

Fig.5

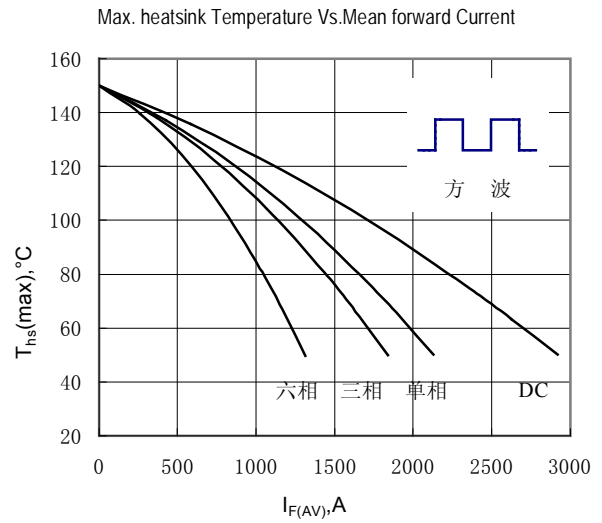

Fig.6

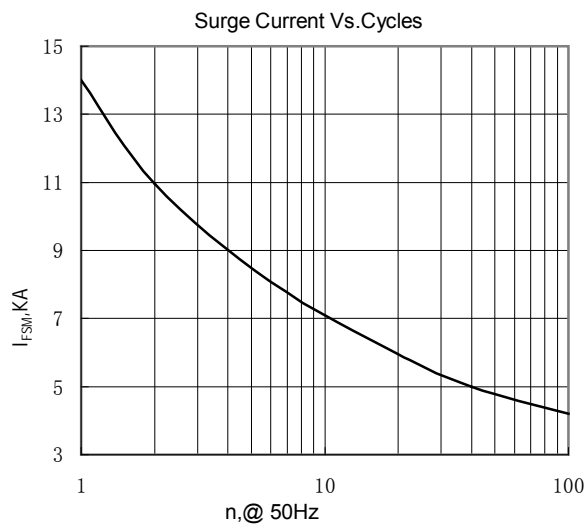

Fig.7

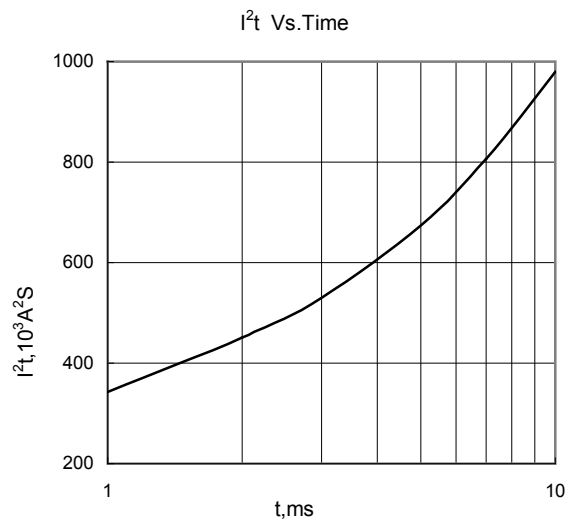
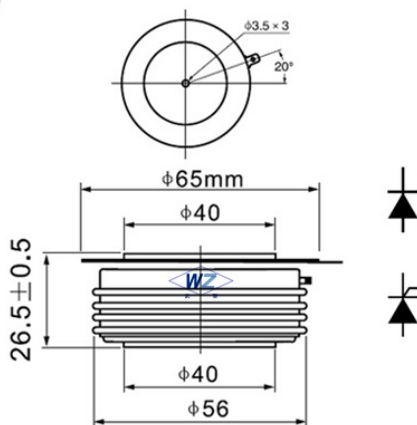

Fig.8

F ko gpurpu<

C18



Wuhan Wuzheng Rectifier Co., Ltd

Add: NO. 73 Gaoxin Five Road, East Lake New Technology Development Zone, Wuhan City, Hubei province.

Tel : 86-27-87001995

Fax: 86-27-87180920

Email: info@techele.com

Web: www.techele.com/en

cn-techele.en.alibaba.com